

TG04-Series



KEY ADVANTAGES

- TG04 can be matched with sensors to reduce energy consumption
- Perfect thermal management for long-term performance
- Wide choice of optics to suit more applications (asymmetrical and symmetrical)
- A cost-effective and very competitive solution offers an industry-leading lux and significant energy savings
- Various mounting options and inclination possibilities on-site for optimal photometry
- Tempered glass cover to effectively reduce UV damage on the lens
- Real beneficial LED alternative to HID floodlights for high-power applications
- Modular combination, multiple power options with complete wattage
- The single module matches the reflector to reduce light pollution

TYPES OF APPLICATION

- INDUSTRIAL HALL&WAREHOUSE
- SPORT FACILITIES
- CAR PARKS
- LARGE AREAS
- BRIDGES
- ROAD&MOTORWAYS
- TUNNEL&UNDERPASSES







5 YEARS WARRANTY

GENERAL INFORMATION

Driver included	Yes
CE mark	Yes
RoHS compliant	Yes
Safety features	Open circuit protection Short circuit protection Overvoltage protection
Testing standard	LM-79 -19 (all measurements in ISO17025 accredited laboratory)

HOUSING AND FINISH

Housing	Aluminium
Optic	Polycarbonate
Protector	Glass
Glass	Tempered glass
Respirator	Yes
Housing finish	Electrostatic polyester powder coating
Standard colour(s)	RAL 9017 black
Tightness level	IP 66
Impact resistance	IK 07

OPERATING CONDITIONS

Operating temperature range (Ta)	-30°C to + 45°C
Operating Humidity	10-90%RH
Mounting Option	Bracket Mounting
Warranty	5 years

PERFORMANCE

Power	50W/100W/150W/200W/ 300W/400W/500W/600W
Efficacy	170lm/W,150lm/W
Power Efficiency	≥86%
Start Time	≤0.2S

ELECTRICAL INFORMATION

Electrical class	Class I EU
Nominal voltage	120-277V 50/60Hz
Power factor (at full load)	0.9
Surge protection options (kV)	6KV-Line-Line 6KV-Line-Earth
Electromagnetic compatibility (EMC)	EN 55015:2019/A11:2020, EN 61000 3-2:2019, EN 61000-3-3:2013, EN 61547:2009, EN 62493:2015
Control protocol(s)	1-10V, DALI2 (optional)
Sensor	Motion sensor (optional)
Total Harmonic Distortion(THD)	IEC 61000-3-2 Class C <20%
Driver Type	Constant current(CC)
Flicker	No
For fixed Class 1 luminaires, overvoltage protective devices which comply with IEC 61643-11 shall be disconnected from the circuit.	
withstand voltage	1.5KV 60S 10mA

※ Lamp switch must control L line or control L and N lines.

OPTICAL INFORMATION

LED Type	SMD3030
Beam Angle	15° / 30° / 45° / 60° / 90° / 120° TYPE2 / TYPE3 / TYPE4 110X20° / 110X40° / 135X60°
Recommended installation height	4m to 15m
Color Tolerance	Ra70 ≤7 Ra80 ≤5
LED colour temperature	3000K / 4000K / 5000K / 5700K / 6500K
Colour rendering index (CRI)	CRI>70 standard CRI>80 optional
Upward Light Output Ratio (ULOR)	0%

※ Ra measurement tolerance is ±2.

LIFETIME OF THE LEDS @ TA 25°C

All configurations	
L70B10	>100,000h
L80B10	>50,000h
L90B10	>30,000h
Switching Cycles	>100,000 times

STANDARD VERSION

POWER	LUMENS	EFFICACY
50W	8,000LM	160LM/W(Ra70)
	7,500LM	150LM/W(Ra80)
100W	17,000LM	170LM/W(Ra70)
	16,000LM	160LM/W(Ra80)
150W	25,500LM	170LM/W(Ra70)
	24,000LM	160LM/W(Ra80)
200W	34,000LM	170LM/W(Ra70)
	32,000LM	160LM/W(Ra80)
300W	51,000LM	170LM/W(Ra70)
	48,000LM	160LM/W(Ra80)
400W	64,000LM	160LM/W(Ra70)
	60,000LM	150LM/W(Ra80)
500W	85,000LM	170LM/W(Ra70)
	80,000LM	160LM/W(Ra80)
600W	96,000LM	160LM/W(Ra70)
	90,000LM	150LM/W(Ra80)

ECO VERSION

POWER	LUMENS	EFFICACY
50W	7,000LM	140LM/W(Ra70)
	6,500LM	130LM/W(Ra80)
100W	15,000LM	150LM/W(Ra70)
	14,000LM	140LM/W(Ra80)
150W	22,500LM	150LM/W(Ra70)
	21,000LM	140LM/W(Ra80)
200W	30,000LM	150LM/W(Ra70)
	28,000LM	140LM/W(Ra80)
300W	45,000LM	150LM/W(Ra70)
	42,000LM	140LM/W(Ra80)
400W	56,000LM	140LM/W(Ra70)
	52,000LM	130LM/W(Ra80)
500W	75,000LM	150LM/W(Ra70)
	70,000LM	140LM/W(Ra80)
600W	84,000LM	140LM/W(Ra70)
	78,000LM	130LM/W(Ra80)

※ Asymmetrical light distribution Reduced light efficiency by 10LM/W
 ※ 15 degrees beam angle Reduced light efficiency by 10LM/W
 ※ 30 degrees beam angle Reduced light efficiency by 5LM/W

※ The Performance Data is tested base on 230VAC, 90° and 4000K for all versions
 ※ Power Consumption Tolerance ±5% (Apply to all versions)
 ※ Lumen Efficiency Tolerance ±5% (Apply to all versions)

PACKAGING

POWER	PACKAGE SIZE	QTY/CTN	SINGLE PIECE VOLUME	NET WEIGHT	GROSS WEIGHT	20GP	40HQ
50W	L570*W285*H330mm	5PCS/CTN	0.0536m ³	3kg	3.4kg	2866pcs	6675pcs
100W	L400*W375*H110mm	1PCS/CTN	0.0165m ³	3.5kg	4kg	2097pcs	4742pcs
150W	L455*W400*H110mm	1PCS/CTN	0.02m ³	4.5kg	5.1kg	1704pcs	3902pcs
200W	L525*W400*H110mm	1PCS/CTN	0.0231m ³	5.2kg	6kg	1485pcs	3408pcs
300W	L615*W465*H135mm	1PCS/CTN	0.0386m ³	10.3kg	11.2kg	784pcs	1835pcs
400W	L615*W465*H135mm	1PCS/CTN	0.0386m ³	10.3kg	11.2kg	784pcs	1835pcs
500W	L735*W575*H145mm	1PCS/CTN	0.0613m ³	15.7kg	17.4kg	453pcs	1059pcs
600W	L735*W575*H145mm	1PCS/CTN	0.0613m ³	15.7kg	17.4kg	453pcs	1059pcs

2866_{PCS}
50W/20GP

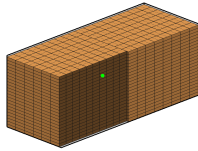

6675_{PCS}
50W/40HQ

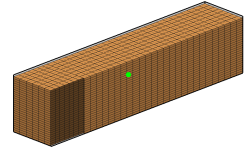

2097_{PCS}
100W/20GP

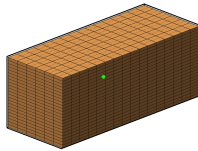

4742_{PCS}
100W/40HQ

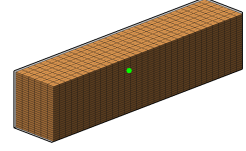

1704_{PCS}
150W/20GP

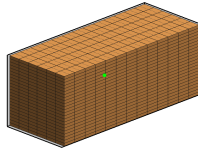

3902_{PCS}
150W/40HQ

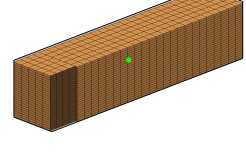

1485_{PCS}
200W/20GP

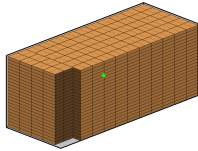

3408_{PCS}
200W/40HQ

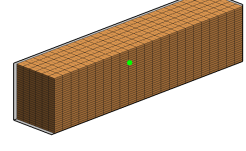

784_{PCS}
300W/20GP

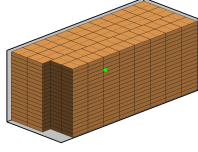

1835_{PCS}
300W/40HQ

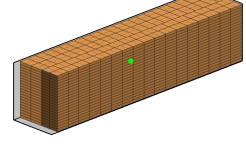

784_{PCS}
400W/20GP

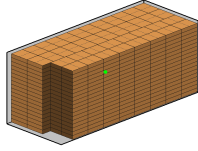

1835_{PCS}
400W/40HQ

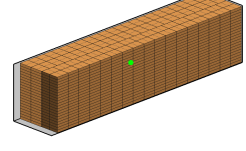

453_{PCS}
500W/20GP

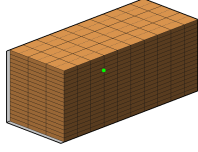

1059_{PCS}
500W/40HQ

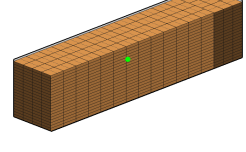

453_{PCS}
600W/20GP

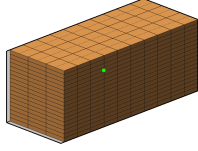

1059_{PCS}
600W/40HQ

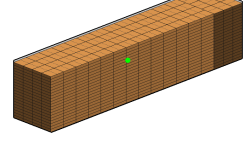

LIGHT DISTRIBUTIONS

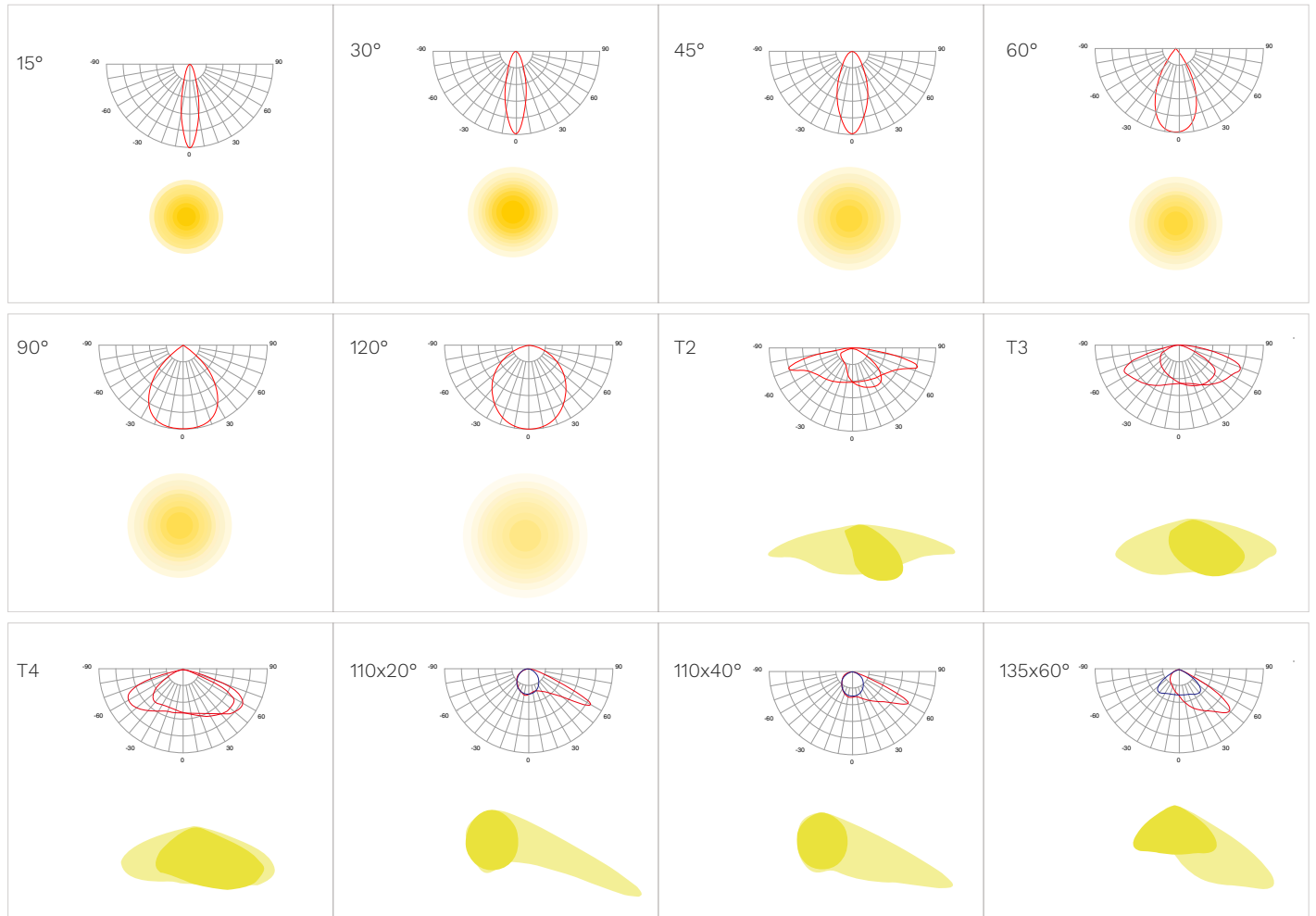

OPTIONAL ACCESSORIES



50W

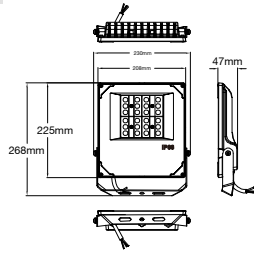

100W

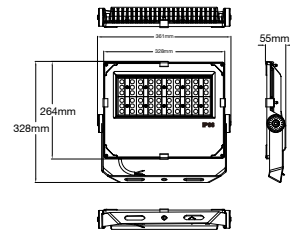

150W

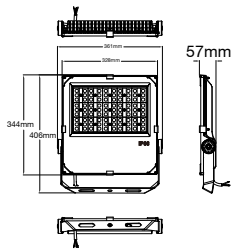

200W

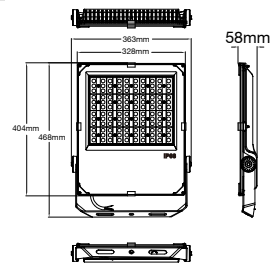

300W/400W

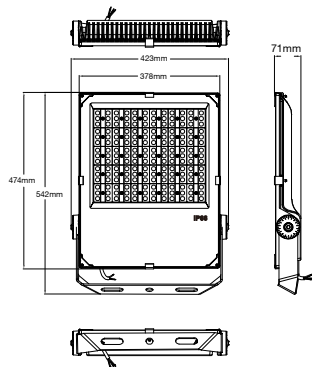

500W/600W

